

# FM/LM Series Thumbweel Switch Setting Type Up/Down Measure Counter

## DIN W72×H72, W144×H72mm Of Up / Down / Up-Down Measure Counter

### ■ Features

- Selectable Multi/Divide function
- Upgrade counting speed: 1cps, 5kcps
- Selectable voltage input (PNP) or no-voltage input (NPN)
- Memory protection for 10 years (using non-voltage semiconductor)
- Decimal point setting (fixed decimal point of display)
- Wide range of power supply : 100-240VAC 50/60Hz, 12-24VAC 50/60Hz, 12-24VDC universal
- Built-in Microprocessor



**⚠ Please read "Caution for your safety" in operation manual before using.**

### ■ Ordering Information

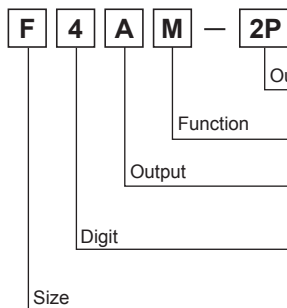

No mark	1-stage preset
2P	2-stage preset
M	Measure function
A	Preset
B	Indicator
4	9999 (4-digit)
6	999999 (6-digit)
F	DIN W72×H72mm
L	DIN W144×H72mm

### ■ Specifications

Model	1-stage preset	F4AM	F6AM	—	—
	2-stage preset	F4AM-2P	F6AM-2P	L4AM-2P	L6AM-2P
	Indicator	F4BM	F6BM	L4BM	L6BM
Digit		4-digit	6-digit	4-digit	6-digit
Digit size		W8×H14mm	W4×H8mm	W8×H14mm	
Power supply	AC voltage	100-240VAC 50/60Hz			
	AC/DC voltage	12-24VAC 50/60Hz, 12-24VDC			
Allowable voltage range		90 to 110% of rated voltage			
Power consumption	AC voltage	• Indicator: Max. 4.7VA • 1-stage preset: Max. 5.6VA • 2-stage preset: Max. 6.5VA (100-240VAC 50/60Hz)			
	AC/DC voltage	• Indicator: Max. 5.1VA • 1-stage preset: Max. 6VA • 2-stage preset: Max. 6.5VA (12-24VAC 50/60Hz) • Indicator: Max. 2.7W • 1-stage preset: Max. 3.3W • 2-stage preset: Max. 3.8W (12-24VDC)			
Max. counting speed		Selectable 1cps/30cps/2kcps/5kcps by internal DIP switch			
Min. input signal width		Approx. 20ms			
Input type	CP1,CP2 input	Input logic is selectable [Voltage input] Input impedance: 5.4kΩ, [H]: 5-30VDC, [L]: 0-2VDC			
	RESET input	[No-Voltage input] Impedance at short-circuit: Max. 1kΩ, Residual voltage at short-circuit: Max. 2VDC, Impedance at open-circuit: Min. 100kΩ			
One-shot output time		• 1-stage preset type - 0.05 to 5sec • 2-stage preset type - 1st. output 0.5sec fixed, 2nd. output: 0.05 to 5sec			
Control output	Contact	Type	1-stage preset: SPDT (1c) 2-stage preset: 1st. output SPST (1a), 2nd. output SPST (1a)	2-stage preset: 1st. output SPDT (1c), 2nd. output SPDT (1c)	
		Capacity	250VAC 3A resistive load		
	Solid state	Type	1-stage preset: 1 NPN open collector output, 2-stage preset: 2 NPN open collector output		
		Capacity	Max. 30VDC, 100mA		
Memory protection		Approx. 10 years (when using non-volatile semiconductor memory)			
External power		12VDC±10% 50mA Max.			

(A) Photoelectric Sensors

(B) Fiber Optic Sensors

(C) Door/Area Sensors

(D) Proximity Sensors

(E) Pressure Sensors

(F) Rotary Encoders

(G) Connectors/ Connector Cables/ Sensor Distribution Boxes/Sockets

(H) Temperature Controllers

(I) SSRs / Power Controllers

(J) Counters

(K) Timers

(L) Panel Meters

(M) Tacho / Speed / Pulse Meters

(N) Display Units

(O) Sensor Controllers

(P) Switching Mode Power Supplies

(Q) Stepper Motors & Drivers & Controllers

(R) Graphic/ Logic Panels

(S) Field Network Devices

(T) Software

# FM/LM Series

## Specifications

Insulation resistance	Over 100MΩ (at 500VDC megger)	
Dielectric strength	2,000VAC 50/60Hz for 1 minute	
Noise immunity	AC voltage	±2kV the square wave noise (pulse width: 1μs) by the noise simulator
	DC voltage	±500V the square wave noise (pulse width: 1μs) by the noise simulator
Vibration	Mechanical	0.75mm amplitude at frequency of 10 to 55Hz (for 1 min) in each X, Y, Z direction for 1 hour
	Malfunction	0.5mm amplitude at frequency of 10 to 55Hz (for 1 min) in each X, Y, Z direction for 10 min
Shock	Mechanical	300m/s <sup>2</sup> (approx. 30G) in each X, Y, Z direction for 3 times
	Malfunction	100m/s <sup>2</sup> (approx. 10G) in each X, Y, Z direction for 3 times
Relay life cycle	Mechanical	Min. 10,000,000 operations
	Electrical	Min. 100,000 operations (250VAC 3A at resistive load)
Environment	Ambient temperature	-10 to 55°C, storage: -25 to 65°C
	Ambient humidity	35 to 85%RH, storage: 35 to 85%RH
Unit weight	AC Voltage type	<b>F4AM</b> : Approx. 273g, <b>F6AM</b> : Approx. 280g, <b>F4AM-2P</b> : Approx. 275g, <b>F6AM-2P</b> : Approx. 282g, <b>F4BM</b> : Approx. 229g, <b>F6BM</b> : Approx. 236g, <b>L4AM</b> : Approx. 505g, <b>L6AM-2P</b> : Approx. 533g, <b>L4AM-2P</b> : Approx. 438g, <b>L6BM</b> : Approx. 445g
	AC/DC Voltage type	<b>F4AM</b> : Approx. 268g, <b>F6AM</b> : Approx. 275g, <b>F4AM-2P</b> : Approx. 270g, <b>F6AM-2P</b> : Approx. 287g, <b>F4BM</b> : Approx. 224g, <b>F6BM</b> : Approx. 231g, <b>L4AM-2P</b> : Approx. 511g, <b>L6AM-2P</b> : Approx. 538g, <b>L4BM-2P</b> : Approx. 444g, <b>L6BM</b> : Approx. 450g

※Environment resistance is rated at no freezing or condensation.

## Connections

### • F4AM-2P / F6AM-2P

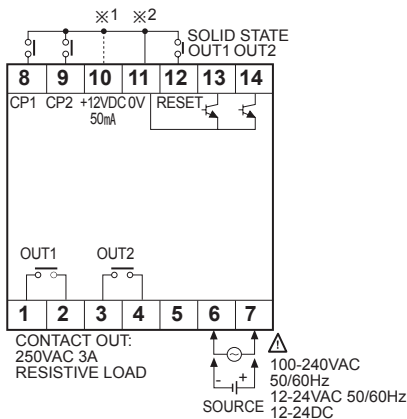

### • F4AM / F6AM

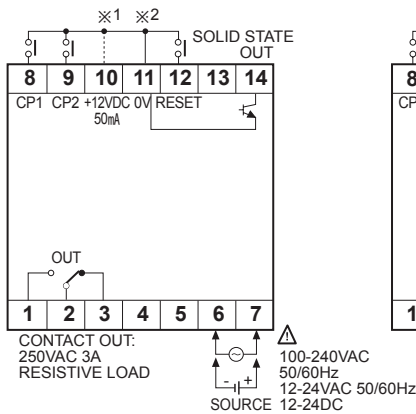

### • F4BM / F6BM

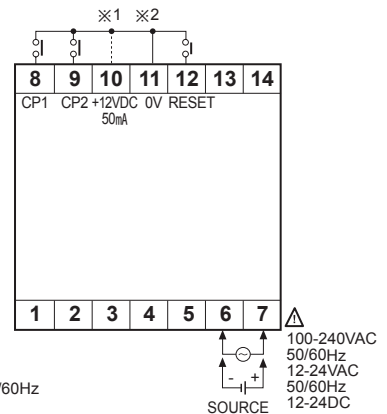

### • L4AM-2P / L6AM-2P

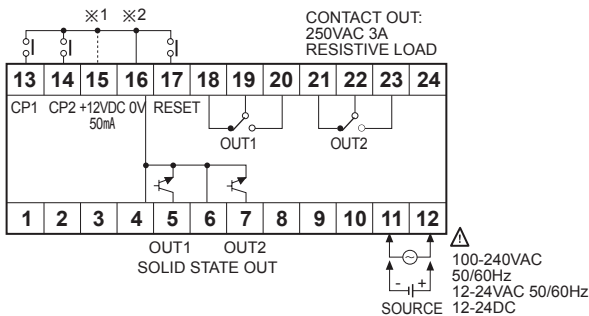

### • L4BM / L6BM

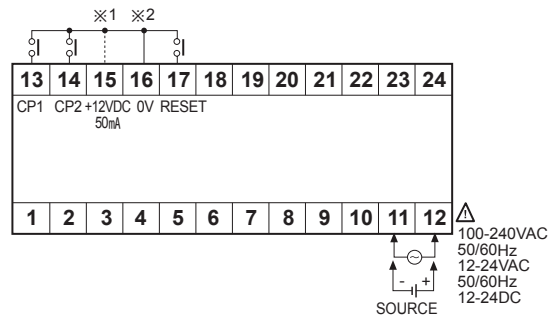

※1: Connection for PNP input in contact input  
 ※2: Connection for NPN input in contact input

# Thumbweel Switch Setting Type Up.Down Measure Counter

## Dimensions

### FM Series

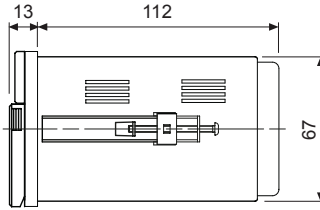
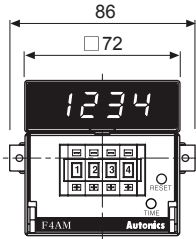

### Panel cut-out

(unit: mm)

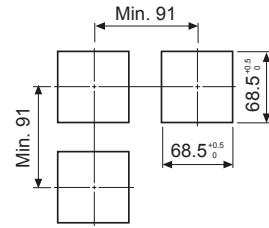

### LM Series

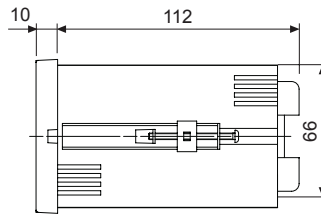
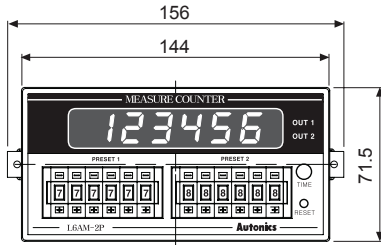

### Panel cut-out

(unit: mm)

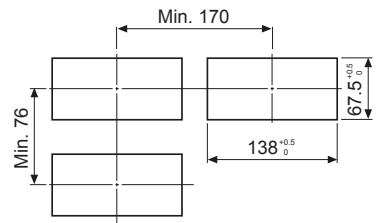

## Input Connections

### No-voltage input (NPN)

#### Solid-state input (Standard sensor: NPN output type sensor)

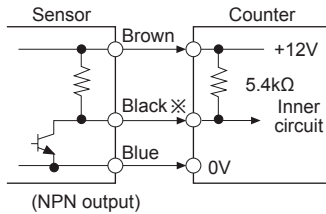

※CP1, CP2, RESET input

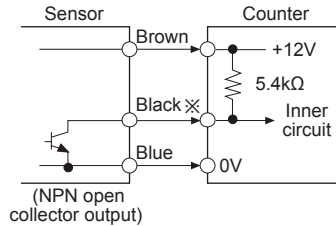

(NPN open collector output)

#### Contact input

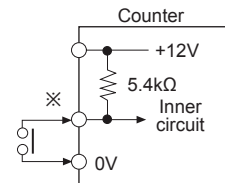

※Counting speed:  
1 or 30cps setting (counter)

### Voltage input (PNP)

#### Solid-state input (Standard sensor: PNP output type sensor)

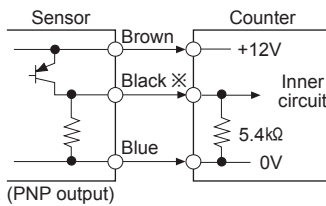

※CP1, CP2, RESET input

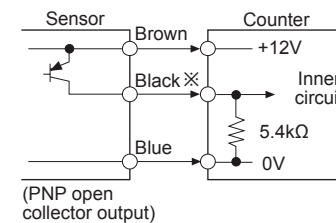

(PNP open collector output)

#### Contact input

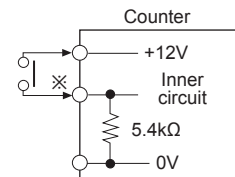

※Counting speed:  
1 or 30cps setting (counter)

(A) Photoelectric Sensors
(B) Fiber Optic Sensors
(C) Door/Area Sensors
(D) Proximity Sensors
(E) Pressure Sensors
(F) Rotary Encoders
(G) Connectors/ Connector Cables/ Sensor Distribution Boxes/Sockets
(H) Temperature Controllers
(I) SSRs / Power Controllers
(J) Counters
(K) Timers
(L) Panel Meters
(M) Tacho / Speed / Pulse Meters
(N) Display Units
(O) Sensor Controllers
(P) Switching Mode Power Supplies
(Q) Stepper Motors & Drivers & Controllers
(R) Graphic/ Logic Panels
(S) Field Network Devices
(T) Software

# FM/LM Series

## ■ Description Of Inner DIP Switches

### ● FM Series

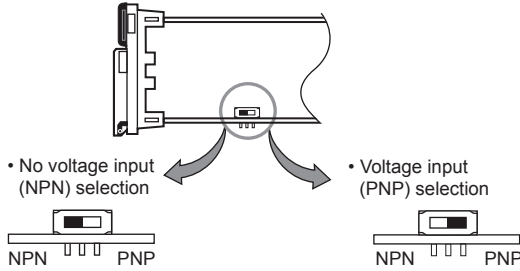

※Please be sure to turn OFF the power before changing input logic.

### ● LM Series

Input logic is changeable by input logic selection switch located at the terminal block.

- No voltage input (NPN) (NPN) F  S (PNP)
- Voltage input (PNP) (NPN) F  S (PNP)

## ■ Input & Output Connections

### ○ In case of operating the load by power supply of the sensor

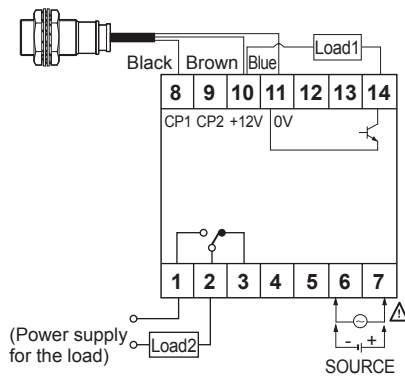

- Please select proper capacity of load, because total value of load capacity and current consumption should not be exceed current capacity (Max. 50mA).

### ○ How to count by external power supply

This unit start to count when "High" level (5-30VDC) is applied at CP1 or CP2 after selecting PNP. ("Low level": 0-2VDC)

### ○ In case of operating the load by external power supply

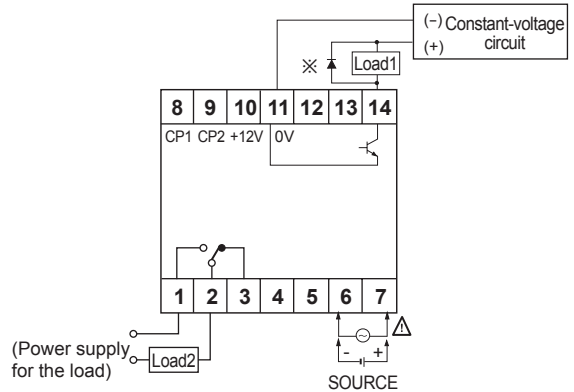

- The capacity of the load must not be exceed Max. 30VDC, Max. 100mA of the switching capacity of the transistor.
- Please do not supply the reverse polarity voltage.
- ※In case of using the inductive load (Relay, etc.), please connector the surge absorber (Diode)at both terminals of the load, in case of using the inductive load.

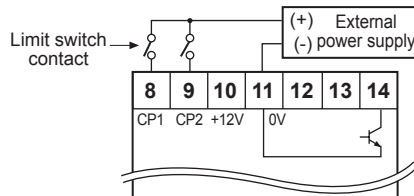

### ○ Using 2 counters with one sensor

- Please connect as the power of sensor is supplied from only one of counters and design input logic with same way.

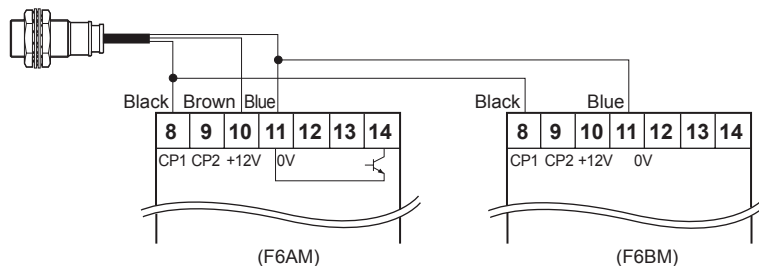

# Thumbwheel Switch Setting Type Up/Down Measure Counter

## ■ Selection By DIP Switches

### ● FM Series

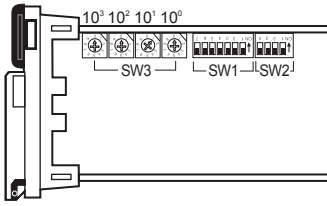

### ● LM Series

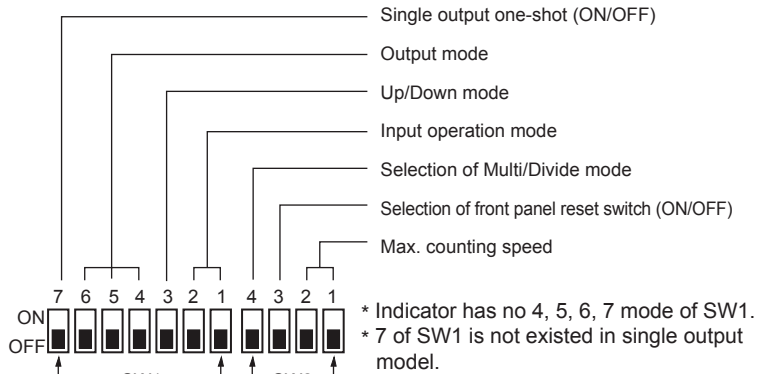
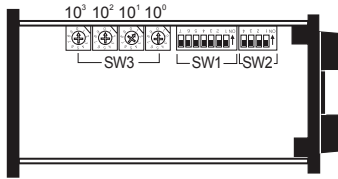

### ● Max. counting speed

SW2	Function
ON <input type="checkbox"/> 1 <input type="checkbox"/> 2 <input type="checkbox"/>	1cps
ON <input type="checkbox"/> 1 <input type="checkbox"/> 2 <input type="checkbox"/>	30cps
ON <input type="checkbox"/> 1 <input type="checkbox"/> 2 <input type="checkbox"/>	2kcps
ON <input type="checkbox"/> 1 <input type="checkbox"/> 2 <input type="checkbox"/>	5kcps

※Factory default: 30cps

### ● Reset switch of front panel

SW2	Function
ON <input type="checkbox"/> 3 <input type="checkbox"/>	Use
ON <input type="checkbox"/> 3 <input type="checkbox"/>	Not used

※Factory default: Not used

### ● Measure function

SW1	Function
ON <input type="checkbox"/> 4 <input type="checkbox"/>	Multi mode
ON <input type="checkbox"/> 4 <input type="checkbox"/>	Divide mode

※Refer to the J-75 for "■ Measure Counter".

※Factory default: Divide mode (SW3:0001)

### ● Up/Down mode selection

SW1	Function
ON <input type="checkbox"/> 3 <input type="checkbox"/>	Up mode
ON <input type="checkbox"/> 3 <input type="checkbox"/>	Down mode

※Factory default: Up mode

### ● Single output one-shot (ON/OFF)

SW1	Function
ON <input type="checkbox"/> 7 <input type="checkbox"/>	One-shot output
ON <input type="checkbox"/> 7 <input type="checkbox"/>	Retained output

※Factory default: Retained output

※This mode selects one-shot output (0.5sec) or remained output (until 2nd output turns off) for 1st output in the 2-stage preset counter.

※Example of F output operation mode

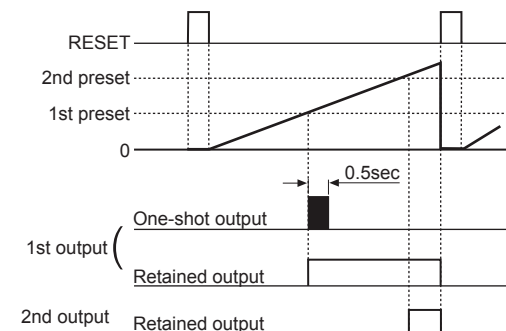

- (A) Photoelectric Sensors
- (B) Fiber Optic Sensors
- (C) Door/Area Sensors
- (D) Proximity Sensors
- (E) Pressure Sensors
- (F) Rotary Encoders
- (G) Connectors/ Connector Cables/ Sensor Distribution Boxes/Sockets
- (H) Temperature Controllers
- (I) SSRs / Power Controllers
- (J) Counters
- (K) Timers
- (L) Panel Meters
- (M) Tacho / Speed / Pulse Meters
- (N) Display Units
- (O) Sensor Controllers
- (P) Switching Mode Power Supplies
- (Q) Stepper Motors & Drivers & Controllers
- (R) Graphic/ Logic Panels
- (S) Field Network Devices
- (T) Software

# FM/LM Series

## ■ Measure Counter

Measure counter sets multiply or divide integer per 1 pulse input.

SW2	Function
4 ON <input type="checkbox"/>	Multi
4 OFF <input type="checkbox"/>	

### ● Multi Mode

It multiplies the inner SW3 setting value at a count input signal and displays it.

Input signal (N) × SW3 preset value = Indication value

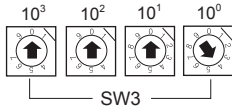

∴ N × 4 = 4, 8, 12 ... (N=1, 2, 3 ...)

SW2	Function
4 ON <input type="checkbox"/>	Divide
4 OFF <input checked="" type="checkbox"/>	

### ● Divide Mode

It displays as 1 when the count input signal is entered as preset value of inner SW3.

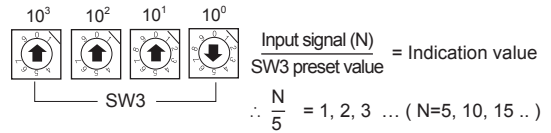

※Please be cautious the error can occur when down count is executed during up count.

## ■ Setting Function Of Decimal Point

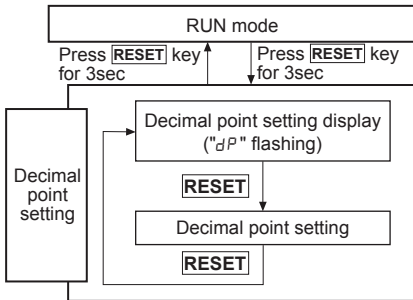

※It advances to "Decimal point setting mode" if press RESET key for 3sec  
 ※It returns to RUN mode by press RESET key for 3sec in "Decimal point setting mode".

※It returns to RUN mode if no RESET button or digital switch (Dual-setting digital switch for 2-stage preset type) is applied for 60sec in the "Decimal point setting mode".

※The decimal point setting is not existed in indicator.

### ● Decimal point setting

• The decimal point setting of 6-digits indicator

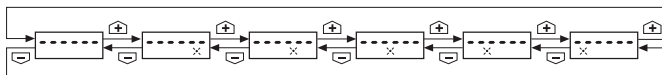

• The decimal point setting of 4-digits indicator

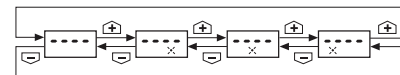

※When it enters to the "Decimal point of setting mode, the prior decimal setting status is displayed.

※In the decimal point setting mode, when pressing one of the Up (⊕) button of digital switch (Dual-setting digital switch for 2-stage preset type), the point is moved to left direction and it is moved to right direction when one of Down (⊖) button of digital switch (Dual-setting digital switch for 2-stage preset type).

## ■ Counting Operation Of Indication Type

### ● Up mode

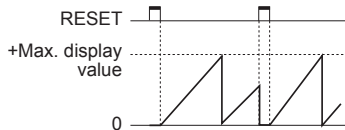

### ● Down mode

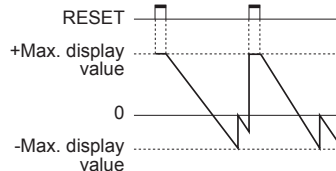

### ● Up / Down-A, B, C mode

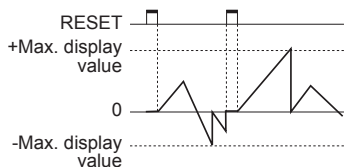

### ● Up / Down-D, E, F mode

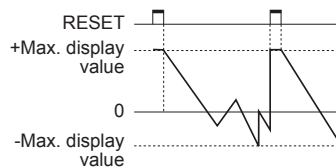

# Thumbweel Switch Setting Type Up/Down Measure Counter

## Input Operation Mode

Input mode (SW1)		SW1	No-voltage input type (NPN)	Voltage input type (PNP)
Up mode	ON  OFF	ON  OFF		
	ON  OFF	ON  OFF		
	ON  OFF	ON  OFF		
	ON  OFF	ON  OFF		
Down mode	ON  OFF	ON  OFF		
	ON  OFF	ON  OFF		
	ON  OFF	ON  OFF		
	ON  OFF	ON  OFF		

※⊗: Over min. signal width, ⊕: Over 1/2 of min. signal width.  
 If the signal width of ⊗ or ⊕ is less than min. signal width, ±1 of count error is occurred.

- (A) Photoelectric Sensors
- (B) Fiber Optic Sensors
- (C) Door/Area Sensors
- (D) Proximity Sensors
- (E) Pressure Sensors
- (F) Rotary Encoders
- (G) Connectors/ Connector Cables/ Sensor Distribution Boxes/Sockets
- (H) Temperature Controllers
- (I) SSRs / Power Controllers
- (J) Counters
- (K) Timers
- (L) Panel Meters
- (M) Tacho / Speed / Pulse Meters
- (N) Display Units
- (O) Sensor Controllers
- (P) Switching Mode Power Supplies
- (Q) Stepper Motors & Drivers & Controllers
- (R) Graphic/ Logic Panels
- (S) Field Network Devices
- (T) Software

# FM/LM Series

## Output Operation Mode

		 One-shot output (0.05 to 5sec) of 2nd output	 Retained output	 One-shot output (0.5sec) of 1st output	 Retained output	※ The output of 1-stage preset type is operated at the status of the second output mode
Output mode (SW1)	3 ON OFF Up mode			3 ON OFF Down mode		
		Up, Up/Down-A, B, C mode	Down, Up/Down-D, E, F mode	Operation after count up		
	ON OFF 4 5 6	 RESET 2nd Preset 1st Preset 0 1st Output 2nd Output	 RESET 2nd Preset 1st Preset 0 1st Output 2nd Output	The display value continues until Reset signal applied and the output is held. <ul style="list-style-type: none"> <li>• 1st retained output and 2nd output are maintained until Reset signal is applied.</li> <li>• When using 1st output as one-shot output, it will return after operating for 0.5sec</li> </ul>		
<b>N</b>	ON OFF 4 5 6	 RESET 2nd Preset 1st Preset 0 1st Output 2nd Output	 RESET 2nd Preset 1st Preset 0 1st Output 2nd Output	Display value and retained output are maintained until Reset signal is applied. <ul style="list-style-type: none"> <li>• When using 1st output as one-shot output, it will return after operating for 0.5sec</li> </ul>		
<b>C</b>	ON OFF 4 5 6	 RESET 2nd Preset 1st Preset 0 1st Output 2nd Output	 RESET 2nd Preset 1st Preset 0 1st Output 2nd Output	The display value will be Reset Start status as soon as it reaches to 2nd setting value. <ul style="list-style-type: none"> <li>• 1st retained output will be OFF after 2nd one-shot output.</li> <li>• 1st one-shot output will be reset after operating 0.5sec, and it is not related to 2nd output.</li> </ul>		
<b>R</b>	ON OFF 4 5 6	 RESET 2nd Preset 1st Preset 0 1st Output 2nd Output	 RESET 2nd Preset 1st Preset 0 1st Output 2nd Output	The display value will be held until 2nd output is OFF then reset. <ul style="list-style-type: none"> <li>• 1st retained output will be OFF after 2nd one-shot output.</li> <li>• 1st one-shot output will be reset after operating 0.5sec, and it is not related to 2nd output.</li> </ul>		
<b>K</b>	ON OFF 4 5 6	 RESET 2nd Preset 1st Preset 0 1st Output 2nd Output	 RESET 2nd Preset 1st Preset 0 1st Output 2nd Output	The display value continues until Reset signal applied. <ul style="list-style-type: none"> <li>• 1st retained output will be OFF after 2nd one-shot output.</li> <li>• 1st one-shot output will be reset after operating 0.5sec, and it is not related to 2nd output.</li> </ul>		
<b>P</b>	ON OFF 4 5 6	 RESET 2nd Preset 1st Preset 0 1st Output 2nd Output	 RESET 2nd Preset 1st Preset 0 1st Output 2nd Output	The display value will be Reset Start status as soon as it reaches to 2nd setting value. <ul style="list-style-type: none"> <li>• 1st retained output will be OFF after 2nd one-shot output.</li> <li>• 1st one-shot output will be reset after operating 0.5sec, and it is not related to 2nd output.</li> </ul>		
<b>Q</b>	ON OFF 4 5 6	 RESET 2nd Preset 1st Preset 0 1st Output 2nd Output	 RESET 2nd Preset 1st Preset 0 1st Output 2nd Output	The display continues until 2nd output is OFF. <ul style="list-style-type: none"> <li>• 1st retained output will be OFF after 2nd one-shot output.</li> <li>• 1st one-shot output will be reset after operating 0.5sec not related to 2nd output.</li> </ul>		
<b>S</b>		Up input	Down input			
	ON OFF 4 5 6	 RESET 2nd Preset 1st Preset 0 1st Output 2nd Output	 RESET 2nd Preset 1st Preset 0 1st Output 2nd Output	<ul style="list-style-type: none"> <li>• Up, Up/Down-A, B, C input mode                             <ul style="list-style-type: none"> <li>- OUT1 is ON when (Display value) <math>\geq</math> (1st setting value)</li> <li>- OUT2 is ON when (Display value) <math>\geq</math> (Dual setting value)</li> </ul> </li> <li>• Down, Up/Down-D, E, F input mode                             <ul style="list-style-type: none"> <li>- OUT1 is ON when (Display value) <math>\leq</math> (1st setting value)</li> <li>- OUT2 is ON when (Display value) <math>\leq</math> (Zero)</li> </ul> </li> </ul>		
		Up/Down-A, B, C	Up/Down-D, E, F			
	ON OFF 4 5 6	 RESET 2nd Preset 1st Preset 0 1st Output 2nd Output	 RESET 2nd Preset 1st Preset 0 1st Output 2nd Output			

※One-shot output time is set by front TIME adjuster.



# Thumbweel Switch Setting Type Up/Down Measure Counter

## ■ Proper Usage

### ○ Reset function

#### ● Reset

In case of changing the input mode after supplying the power, please take an external reset or manual reset. **If reset is not executed, the counter will be working as previous mode.**

#### ● Reset signal width

It is reset perfectly when the reset signal is applied during **min. 20ms** regardless of the contact input & solid-state input.

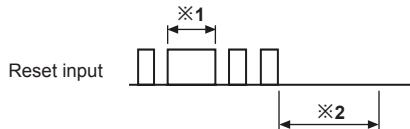

※1: In case of a contact reset, it is reset perfectly if the ON time of reset signal is applied during Min. 20ms even though a chattering occurs.

※2: It can be input the signal of CP1 & CP2 after Min. 50ms from closing time of reset signal.

### ○ Min. signal width

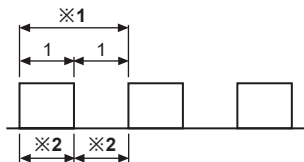

※1: Please make duty ratio (ON:OFF) 1:1.

※2: Min. signal width

- 1cps: Min. 500ms
- 30cps: Min. 16.7ms
- 2kcps: Min. 0.25ms
- 5kcps: Min. 0.1ms

### ○ Max. counting speed

This is a response speed per 1 sec when the duty ratio (ON/OFF) of input signal is 1:1. If the duty ratio is not 1:1, the width between ON and OFF should be over min. signal width and the response speed is getting slower against input signal. If either ON or OFF signal is shorter than minimum signal width, this product may not respond.

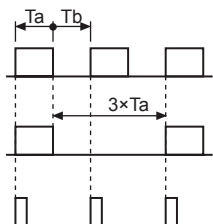

$T_a$  (ON width) and  $T_b$  (OFF width) need to be over min. signal width.

Max. counting speed is 1/2 value of rated spec. when duty ratio is 1:3. It can not respond if it is smaller than min. signal width ( $T_a$ ).

### ○ Error display

Error signal	Error description	Returning method
Err 0	The state that second preset is 0	Change the setting value to non zero status

※When Error is displayed, the output continues OFF state.  
 ※1st output maintains OFF status by set 1st setting value as 0.  
 ※There is no Error function in indicator.

### ○ Detach the case from body

Cut OFF the power to the counter before detaching the case.

#### ● FM Series

Unscrew the front bolt, and pull the body forward.

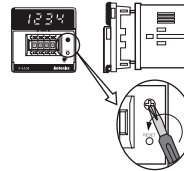

#### ● LM Series

Unscrew the rear bolt, and pull the body forward.

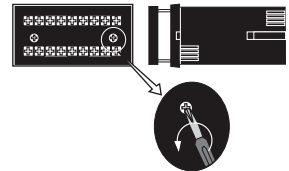

### ○ Power

● The inner circuit voltage starts to rise up for the first 100ms after power on, the input may not work at this time. And also the inner circuit voltage drops down for the last 500ms after power off, the input may not work at this time.

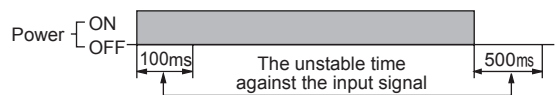

● Please use the power within rated power and apply or cut the power at once to prevent from chattering.



### ○ Input signal line

● Shorten the cable distance between the sensor and this product.  
 ● Please use shield wire for input signal needed to be long.  
 ● Please wire input signal line separated from power line.

### ○ Test circuit dielectric, impulse voltage and measure insulated resistor by installing in control panel

● Separate the unit from control box circuit.  
 ● Short-circuit all terminals in terminal block.

### ○ Do not use this unit at below places.

● Place where there is severe vibration or impact.  
 ● Place where strong alkalis or acids are used.  
 ● Place where there is direct ray of the sun  
 ● Place where strong magnetic field or electric noise is generated.

### ○ This unit may be used in the following environments.

● Indoor  
 ● Altitude: Under 2,000m  
 ● Pollution degree 2  
 ● Installation category II

(A) Photoelectric Sensors

(B) Fiber Optic Sensors

(C) Door/Area Sensors

(D) Proximity Sensors

(E) Pressure Sensors

(F) Rotary Encoders

(G) Connectors/ Connector Cables/ Sensor Distribution Boxes/Sockets

(H) Temperature Controllers

(I) SSRs / Power Controllers

(J) Counters

(K) Timers

(L) Panel Meters

(M) Tacho / Speed / Pulse Meters

(N) Display Units

(O) Sensor Controllers

(P) Switching Mode Power Supplies

(Q) Stepper Motors & Drivers & Controllers

(R) Graphic/ Logic Panels

(S) Field Network Devices

(T) Software